

ARTIGLIO MASTER JOLLY



CONVENTIONAL
LOW PROFILE
RUN FLAT



1100 mm / 43"



360 mm / 14"



12" ÷ 26"



 Artiglio Master JOLLY
il cuore della tecnologia "Leva la Leva"

 Artiglio Master JOLLY
the heart of the "Leva la Leva" technology

 Artiglio Master JOLLY
Das Herz der Technologie "Leva la Leva"

ARTIGLIO MASTER JOLLY



 Dal 2001, anno d'introduzione della nostra tecnologia "Leva la leva" qualcuno si è affrettato a rincorrerci presentando le proprie soluzioni, chi chiamandole "senza leva", chi "leverless", chi "sistema di leva automatica". La verità però è che nessuno ha potuto copiare il sistema brevettato "Leva la leva" con dispositivo "SMART Corghi System", l'unico esistente che:

- **NON TOCCA MAI IL CERCHIO**, in nessuna delle fasi di lavoro
- annulla qualunque tensione sul pneumatico durante le fasi di smontaggio/montaggio dello pneumatico

Questa è la differenza fra Corghi e gli altri.

Artiglio Master Jolly ha nel cuore questa tecnologia e la porta in una fascia di prezzo finora impensabile. Sintesi perfetta tra qualità costruttiva collaudata, soluzioni tecnologiche uniche e prezzo competitivo rappresenta la macchina ideale e l'equilibrio perfetto per un investimento che dal 2001 garantisce ai nostri clienti un vantaggio tecnologico ineguagliabile nel tempo.

I LEVA LA LEVA NON SONO TUTTI UGUALI! E noi lo sappiamo bene.

 Since 2001, the year our "Leva la leva" technology was introduced, many hurried to chase after us, presenting their own solutions. They called their solutions "no lever", or "leverless", or the "automatic lever system". The truth is however that no one has been able to copy the patented "Leva la leva" system with the "SMART Corghi System" device, the only existing solution that:

- **NEVER TOUCHES THE RIM**, during any working phase
- annuls all tension on the tyre during the tyre demounting/mounting phases.

This is the difference between Corghi and the others.

Artiglio Master Jolly has this technology at its core and offers it in a price range that has been impossible until now. A perfect synthesis between tested constructive quality, unique technological solutions and a competitive price represents the ideal machine and a perfect balance for an investment that since 2001 has guaranteed our customers a technological advantage that has remained unmatched over time.

NOT ALL LEVA LA LEVA SOLUTIONS ARE EQUAL! And we are well aware of this.

 Seit 2001, dem Jahr, in dem unsere Technologie "Leva la Leva" eingeführt wurde, haben einige sich beeilt, uns nachzueifern und eigene Lösungen vorzustellen, mit ganz unterschiedlichen Bezeichnungen: "ohne Hebel", "Leverless" oder "System des automatischen Montiereisens". Die Wahrheit ist jedoch, dass es niemandem gelungen ist, das patentierte System "Leva la Leva" mit Vorrichtung "SMART Corghi System" nachzuahmen, das einzige auf dem Markt, das:

- **NIE DIE FELGE BERÜHRT**, in keiner der Arbeitsphasen
- jegliche Spannung am Reifen während der Phasen der Demontage/Montage des Reifens aufhebt.

Das ist der Unterschied zwischen Corghi und den anderen.

Artiglio Master Jolly hat diese Technologie im Herzen und bringt sie in eine bisher undenkbare Preisklasse. Die perfekte Synthese zwischen bewährter baulicher Qualität, einzigartigen technischen Lösungen und einem konkurrenzfähigen Preis. Die ideale Maschine und das perfekte Gleichgewicht für eine Investition, die seit 2001 unseren Kunden einen technischen Vorteil garantiert, der auf Dauer nichts Vergleichbares hat.

Die LEVA LA LEVA SIND NICHT ALLE GLEICH! Und wir wissen das gut.

- **Consolle ergonomica e multifunzionale** con display che permette di impostare elettronicamente il diametro del cerchio ed ottenere in modo veloce, pratico e sicuro il posizionamento degli utensili di lavoro; suddivisa in tre distinte aree di lavoro che rende più immediato il riconoscimento dei movimenti e facilita l'uso da parte dell'operatore.

- **Ergonomic and multifunctional consoles** with a display that makes it possible to electronically set the rim diameter and obtain the positioning of the work tools in a quick, practical and safe manner. Divided into three distinct work areas, it makes it easier to immediately recognize movements and makes the system easier to use for the operator.

- **Ergonomisches Multifunktions-Bedienpult** mit Display, das es ermöglicht, den Felgendurchmesser elektronisch einzustellen und die Arbeitswerkzeuge schnell, praktisch und sicher zu positionieren. Es ist in drei verschiedene Arbeitsbereiche unterteilt, wodurch die Arbeitsbewegungen unmittelbar erkennbar sind und die Bedienung erleichtert wird.



1

2



- **Dispositivo di stallonatura dinamica** con doppio disco stallonatore speculare. Il posizionamento radiale dei dischi è facilitato da un automatismo in grado di evitare ogni posizionamento manuale dell'operatore.

Penetrazione controllata (Patent Pending) precisione, rapidità e ripetitività sono garantiti dal sistema di stallonatura brevettato e dalla perfetta specularità tra i due dischi.

- **Dynamic bead breaking device** with dual specular bead breaker disc. The radial positioning of the discs is made easier by an automatism that is able to prevent any manual positioning by the operator.

Controlled penetration (Patent Pending) Precision, rapidity and repeatability are guaranteed by the patented bead breaking system and by the perfectly synchronized and symmetrical motions of the two discs.

- **DYNAMISCHE ABRÜCKVORRICHTUNG** mit doppelter und gespiegelter Abdrückscheibe. Die Radiale Positionierung der Scheiben wird durch eine Automatik vereinfacht, die in der Lage ist, jede manuelle Positionierung von Seiten des Bedieners zu vermeiden. **KONTROLLIERTE EINDRINGTIEFE** (Patent pending) Präzision, Schnelligkeit und Wiederholbarkeit sind von dem patentierten Abdrücksystem und der perfekten Spiegelgleichheit der beiden Scheiben gewährleistet.

2



ARTIGLIO MASTER JOLLY

- Utensile di smontaggio e montaggio tallone con ricerca automatica del tallone e movimento di smontaggio **Smart Corghi System** in grado di ridurre la tensione sullo pneumatico **senza toccare mai il cerchio**.
- *Bead demounting and mounting tool with automatic bead searching and **Smart Corghi System** demounting movement able to reduce the tension on the tyre **without ever touching the rim**.*
- Demontage- und Montagewerkzeug des Wulstes mit automatischer Wulstsuche und Demontagebewegung **Smart Corghi System**, mit der die Spannung am Reifen reduziert wird, **ohne je die Felge zu berühren**.

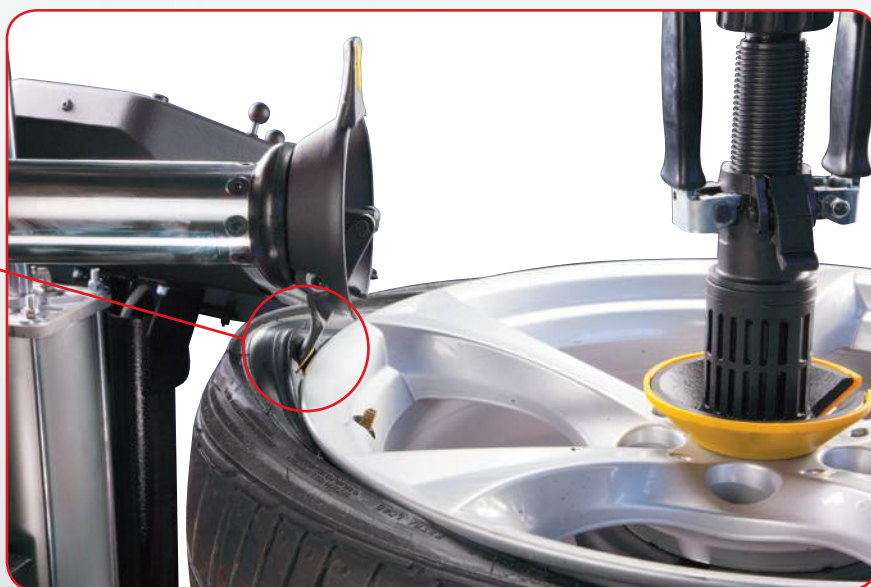
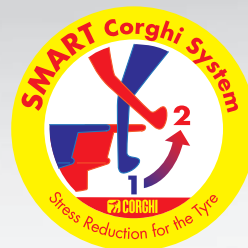

3



- Ricerca automatica del tallone del pneumatico senza alcun contatto con il cerchio indipendentemente dalla sua forma.
- *Automatic location of the tyre bead, with no contact with the rim itself, regardless of its shape.*
- Automatisches Anstellen an den Reifenwulst unabhängig von seiner Form und ohne jeden Kontakt mit der Felge.

4

- **BLOCCAGGIO RUOTA SICURO E UNIVERSALE**

L'autocentrante a platorello consente un rapido bloccaggio, permettendo inoltre la stallonatura di entrambi i fianchi senza bisogno di capovolgere la ruota. L'altezza di lavoro costante (eccetto con cerchi rovesci) è studiata per una perfetta ergonomia nei movimenti dell'operatore con ogni tipo di ruota.

- **SAFE AND UNIVERSAL WHEEL CLAMPING**

The axial mounting turntable ensures rapid clamping while permitting bead breaking on both sides without having to turn the wheel itself. The constant working height (reverse rims excluded) has been optimised for ideal operator ergonomics with all wheel types.

- **RADBLOCKIERUNG SICHER UND UNIVERSELL**

Der Spannteller ermöglicht eine schnelle Blockierung und außerdem das Abdrücken beider Seiten, ohne dass das Rad gedreht werden muss. Die gleichbleibende Arbeitshöhe (außer bei umgekehrten Felgen) wurde für eine perfekte Ergonomie in den Bewegungen des Bedieners mit jedem Radtyp entwickelt.



4



- L'**autocentrante a platorello** consente il bloccaggio sicuro e veloce della ruota e permette la stallonatura di entrambi i fianchi in una sola presa (senza bisogno di girare la ruota).

- **Axial mounting turntable** allows quick, secure wheel clamping and bead breaking on both sides with no need to turn the wheel over (wheel is clamped on the machine just once).

- Der **Spannteller** mit Scheibe gestattet das sichere und schnelle Einspannen des Rads und ermöglicht das Abdrücken beider Seiten mit einer einzigen Einspannposition (ohne Umdrehen des Rads).

- Procedura rapida con **disco stallonatore** (particolarmente indicata con fianchi duri) per lo smontaggio del tallone inferiore

- *Rapid bottom bead demounting procedure with **bead breaker disc** (particularly useful with stiff sidewalls)*

- Schnellverfahren mit **Abdrückscheibe** (vor allem bei harten Seiten empfohlen) für die Demontage des unteren Wulstes

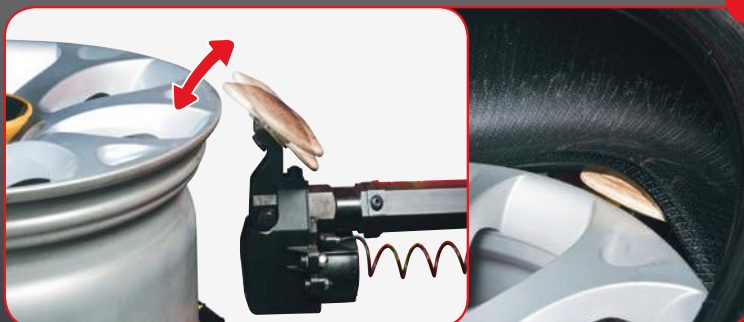

5

ARTIGLIO MASTER JOLLY

- Premittallone ad altezza di lavoro regolabile
- La forma del pressore è ideale per pneumatici RFT
- Di serie in tutte le versioni
- *Bead depressor with adjustable working height*
- *Depressor shape ideal for RFT tyres*
- *Standard in all versions*
- *Wulstniederhalter mit einstellbarer Arbeitshöhe*
- *Die Form des Niederhalters ist ideal für RFT-Reifen*
- *Serienmäßig bei allen Versionen*



6



• Posizione fissa di lavoro

Pedali, consolle, vaschetta e caricamento ruota sullo stesso lato e un' altezza di lavoro costante per ottenere una perfetta ergonomia nei movimenti.

• Fixed work position

Pedals, consoles, tray and wheel loading on the same side and a constant working height to obtain perfectly ergonomic movements.

• Feste Arbeitsposition

Pedale, Bedienpult, Schale und Laden des Rads auf derselben Seite und eine gleichbleibende Arbeitshöhe, für eine perfekte Ergonomie bei den Bewegungen.

- **SENZA FATICA** Il sollevatore consente di posizionare sull'autocentrante ogni tipo di ruota senza sforzo (a richiesta).
- **EFFORTLESS OPERATION** A wheel lifter for effortlessly placing wheels of any type onto the turntable (optional accessory)
- **MÜHELOS** Hebevorrichtung ermöglicht es, jede Art Reifen ohne Anstrengung auf dem Spannteller zu positionieren (Zubehör auf Anfrage).



7



- Flangia per cerchi Furgone
- *Pick-up rim kit*
- Kit Transporterräder



- Flangia universale per cerchi ciechi e per cerchi con il foro centrale del cerchio a bordo sottile o delicato
- *Universal flange for closed rims and for rims with the central hole of the rim with thin or delicate edges*
- Universal-Flansch für geschlossene Felgen und für Felgen deren Mittelloch einen dünnen oder feinen Rand haben



- Flangia per ruote a canale rovescio
- *Reverse wheel flange*
- Flansch für Räder mit umgekehrtem Kanal



- Kit intallamento rapido
- *TI system Kit*
- Bausatz für schnelles Wulsteindrücken: TI-System

ACCESSORI IN DOTAZIONE - STANDARD ACCESSORIES - SERIENMÄSSIGE AUSSTATTUNG



DATI TECNICI	TECHNICAL DATA	TECHNISCHE DATEN	
range dimensioni ruota	wheel dimension range	Radabmessungen	
diametro cerchio	rim diameter	Felgendurchmesser	12" ÷ 26"
diametro max pneumatico	maximum tyre diameter	Max. Reifendurchmesser	1100 mm (*)
larghezza massima pneumatico	maximum tyre width	Max. Reifenbreite	360 mm (14")
pneumatici trattabili	tyre types processed	Reifentypen	convenzionali, low profile e Run Flat conventional, low profile and Run Flat Standardreifen, Low-Profile und Run-Flatreifen
autocentrante	turntable	Selbstzentrierendes Spannutter	
bloccaggio	clamping	Aufspannung	manuale - manual - manuelle
motorizzazione	drive system	Antrieb	motoinverter 2 velocità - 2 speed motoinverter - Motoinverter mit 2 Geschwindigkeiten
coppia di rotazione	rotation torque	Rotationsdrehmoment	1100 Nm
velocità di rotazione	rotation speed	Drehzahl	7 - 18 rpm
stallonatore	bead breaker	Abdrücker	
campo massimo di stallonatura	maximum bead breaking range	Max. Abdrückbereich	18"
corsa stallonatore	bead breaker stroke	Hub der Abdrückvorrichtung	450 mm
forza stallonatore	bead breaker force	Kraft der Abdrückvorrichtung	7600 N
carico / scarico ruota	wheel loading / unloading	Auf-/Abladen des Rads	
azionamento	operation	Antrieb	pneumatico - pneumatic pneumatisch
peso max ruota	max wheel weight	Max. Radgewicht	85 Kg
alimentazione	power supply	Versorgung	
elettrica 1Ph	electric 1Ph	elektrisch 1 Ph	230V - 0,98 kW 50 Hz
elettrica 1Ph (alternativa)	electric 1Ph (alternative)	elektrisch 1 Ph (alternativ)	110V - 0,98 kW 60 Hz
pneumatica di esercizio	pneumatic operating pressure	Betriebsdruck	8 ÷ 9,5 bar (min.)
peso	weight	Gewicht	400 kg (T.I.= 415 kg)
imballo (L x P x H)	packaging (L x D x H)	Verpackung (B x T x H)	1240 x 1500 x 1840
peso con imballo	packaging weight	Gewichtverpackung	440 kg (T.I.=455 kg)

*variabile con il variare della dimensione del cerchio - it changes according to rim size - Verändert sich aufgrund der verschiedenen Felgenreößen

DIMENSIONE TOTALE • OVERALL DIMENSIONS • ABMESSUNGEN

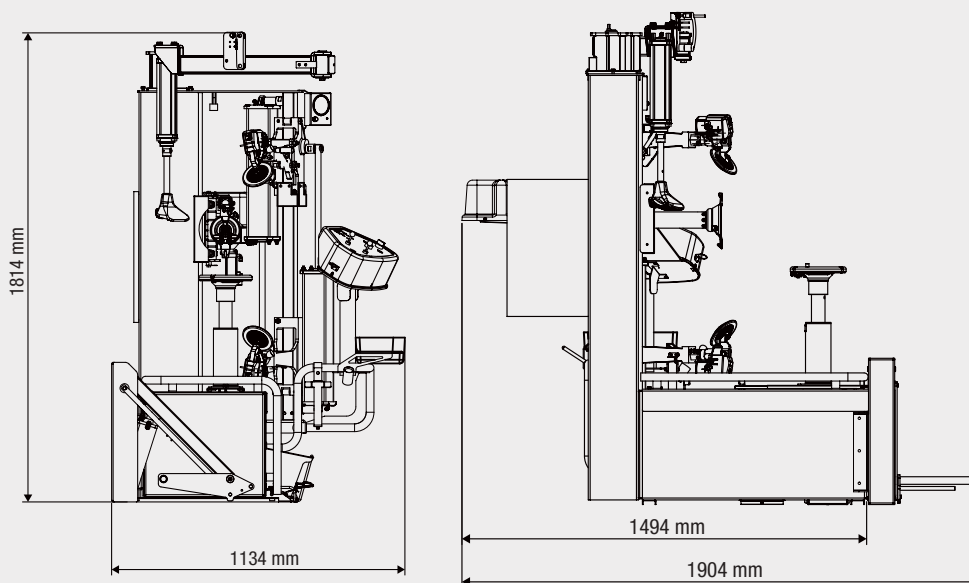

Per aiutare il pianeta ottimizzando il consumo di carta, i nostri cataloghi sono consultabili sul sito www.corghi.com. Una stampa responsabile aiuta a preservare l'ambiente.
To protect the planet and reduce paper usage, our catalogues are viewable online at the website www.corghi.com. Printing responsibly contributes to saving the environment.

Fotografie, caratteristiche ed i dati tecnici non sono vincolanti, possono subire modifiche senza preavviso. The manufacturer reserves the right to modify the features of its products at any time. Die Fotografien und die angegebenen Eigenschaften und technischen Daten sind nicht verbindlich und können ohne Vorankündigung geändert werden.
Cod./Code/Code DPC6000519 - 09/2013

CORGHI



<http://www.facebook.com/CORGHIspa>



<https://twitter.com/corghispa>



<http://www.youtube.com/CORGHIspa>

CORGHI S.p.A. a NEXION GROUP COMPANY - Strada Statale 468 n° 9 - 42015 CORREGGIO - R.E. - ITALY
Tel. ++39 0522 639.111 - Fax ++39 0522 639.150 - www.corghi.com - info@corghi.com

