



HD 500

Smontagomme semi-automatico per pneumatici fino a 26"

Semi automatic tyre changer for tyre size up to 26"

Halbautomatische Reifenmontiermaschine für Reifen mit bis zu 26"

26"

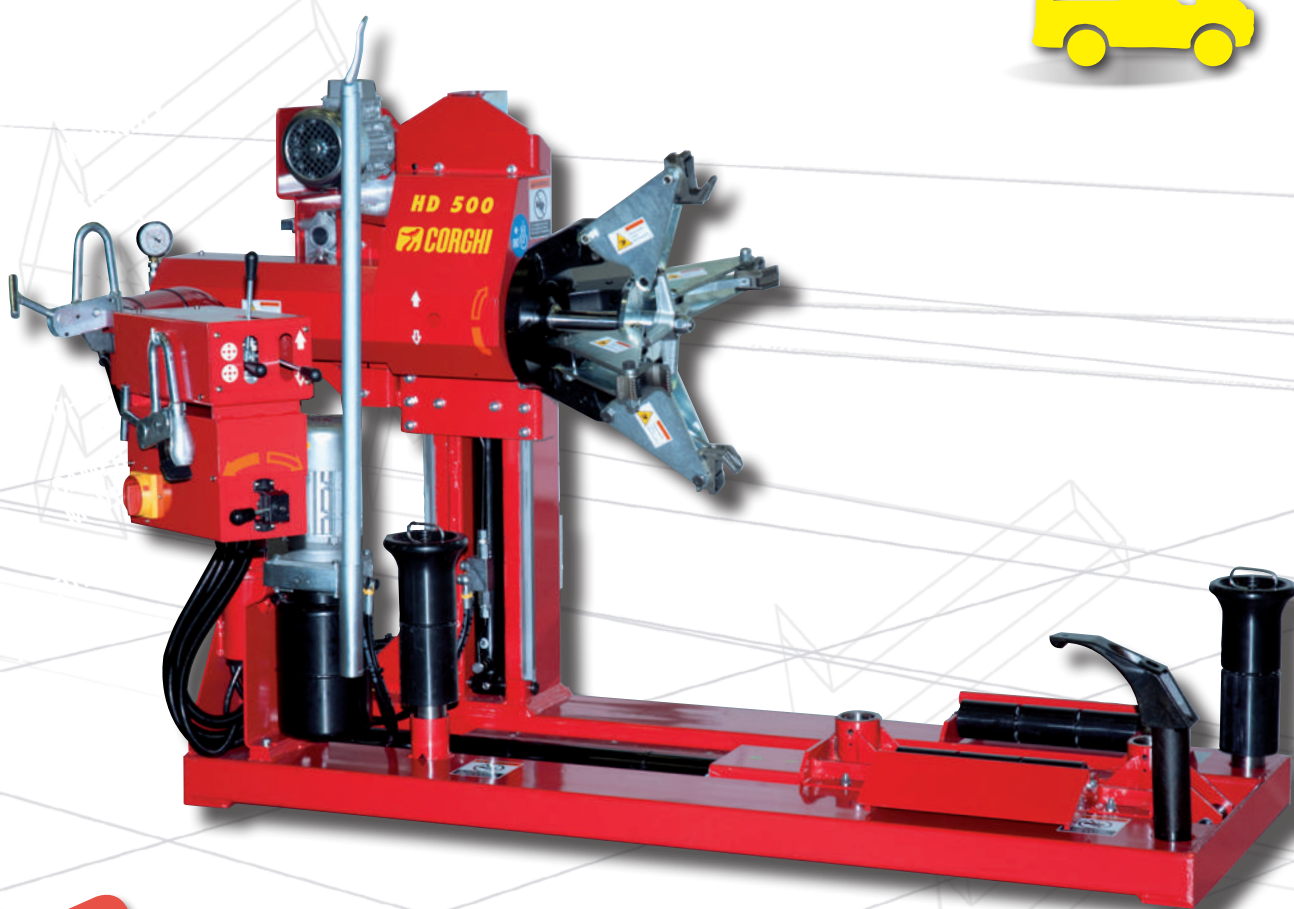
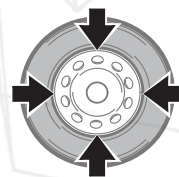

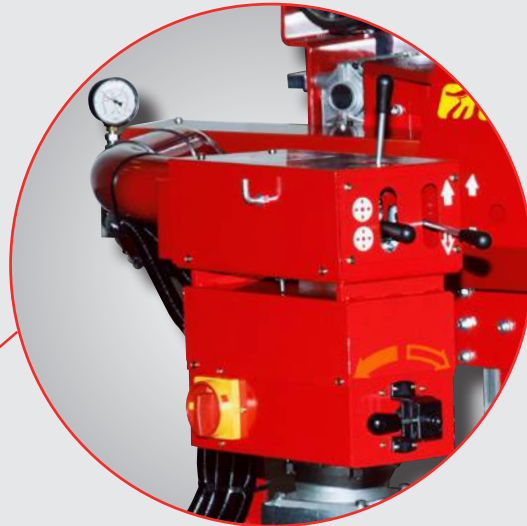

Nuovo smontagomme, compatto, veloce e facile da usare. Totalmente idraulico.

New, compact tyre changer that is fast and easy to use. Fully hydraulic.

Neue Reifenmontiermaschine, kompakt, schnell und einfach in der Anwendung. Komplette hydraulisch..

3

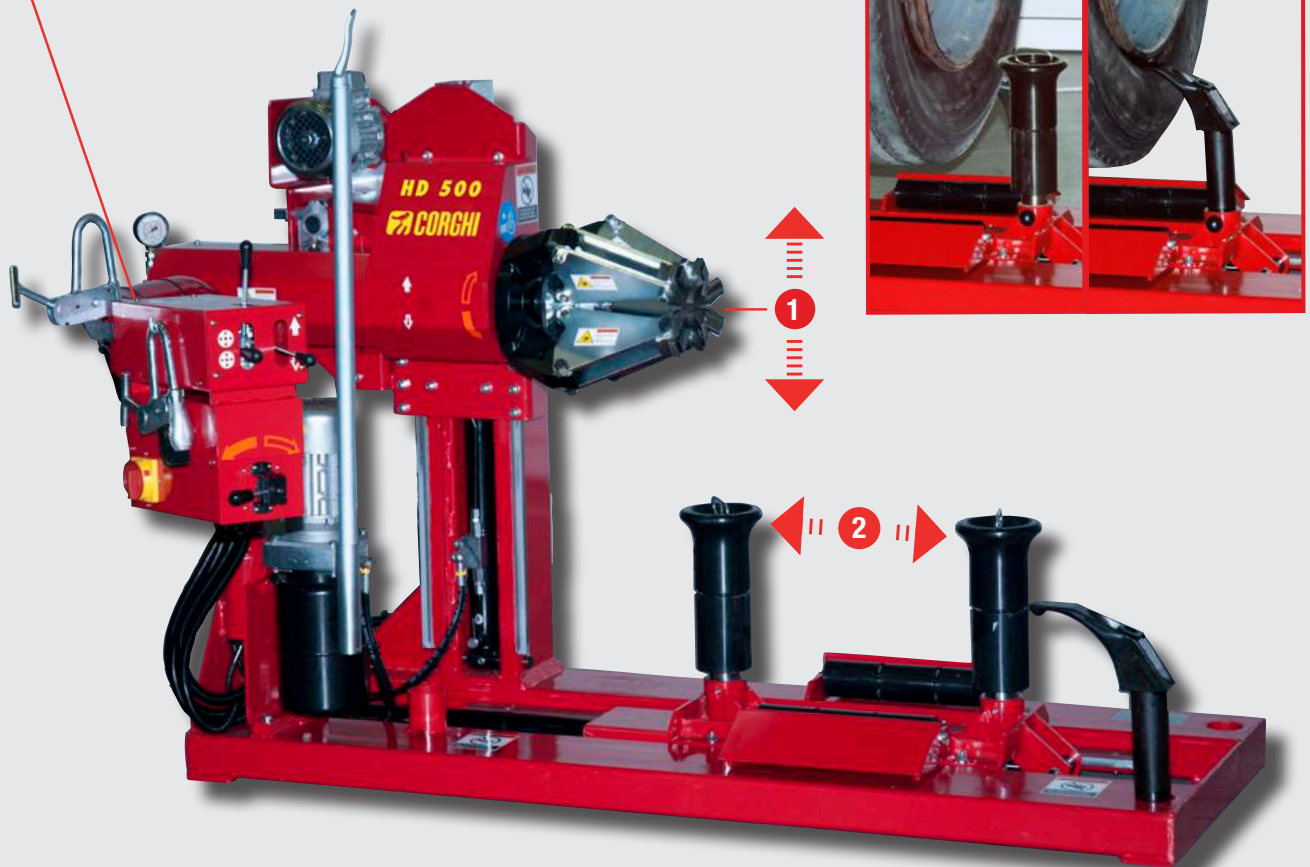

1 2

Grazie ai 2 carrelli , porta mandrino e utensili, ad azionamento idraulico, la ruota viene rapidamente movimentata. Questa si trova sempre nella condizione ottimale per essere smontata e rimontata.

The 2 hydraulic-powered trolleys, the chuck holder and the tool carriage, allow the wheel to be moved rapidly. This always puts it in the best condition to be demounted and mounted.

Dank der 2 Trägerwagen für die Spannvorrichtung und Werkzeuge mit hydraulischer Betätigung wird das Rad schnell transportiert. Dieses befindet sich stets in der optimalen Position für Demontage und Montage.

3

Consolle comandi ad azionamento diretto idraulico. Comandi ergonomici e istantanei per fare della velocità la miglior caratteristica dell HD500.

Control unit with direct hydraulic drive. The ergonomic and instantaneous controls make speed the leading characteristic of the HD500.

Steuerkonsole mit direkter hydraulischer Betätigung. Ergonomische und schnell ansprechende Bedienelemente, sodass sich das Modell HD500 vor allem durch Geschwindigkeit auszeichnet.

VELOCITÀ - SPEED - GESCHWINDIGKEIT

Autocentrante ad azionamento idraulico compatto e polivalente. Può bloccare cerchi da 14" fino a 26". La struttura appositamente studiata, garantisce spostamenti veloci senza speco di tempo ed energia.

Compact and multi-purpose turntable with hydraulic drive. Able to clamp rims ranging in size from 14" to 26". This structure was expressly studied to guarantee rapid movement that doesn't waste time or energy.

Kompaktes und polyvalenter Spannutter mit hydraulischer Betätigung. Kann Felgen von 14" bis 26" spannen. Die eigens entwickelte Struktur garantiert schnelle Bewegungen ohne Zeit- und Energieverlust.

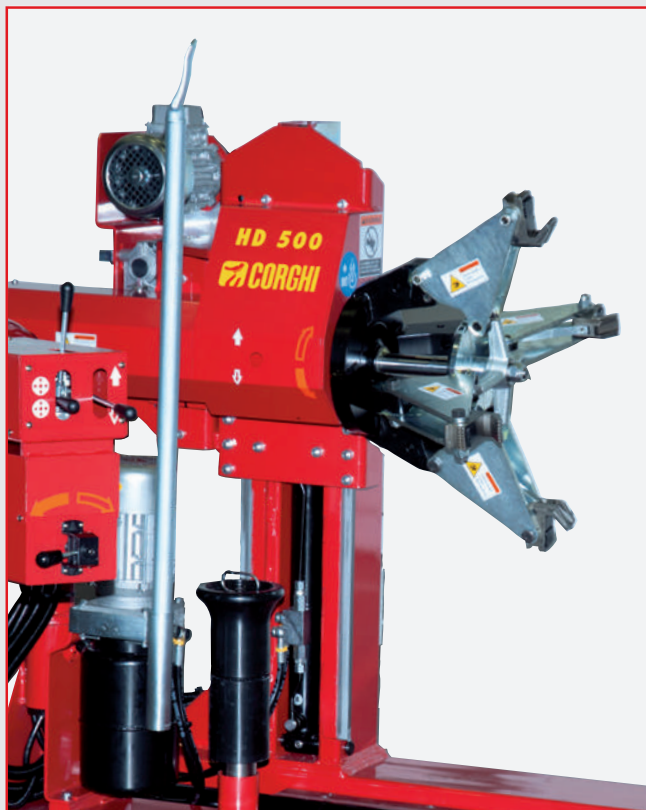

SICUREZZA - SAFETY - SICHERHEIT

L'autocentrante è provvisto di un dispositivo di sicurezza che ne evita la chiusura accidentale. Il cilindro che alza il carrello autocentrante è provvisto di valvola di sicurezza che evita l'accidentale caduta del carrello e ruota. Una valvola di massima pressione garantisce che lo smontagomme lavori al massimo delle performance.

The turntable is equipped with a safety device that prevents accidental closure. The cylinder that lifts the turntable trolley has a safety valve that prevents the trolley and the tyre from falling accidentally. A pressure-relief valve guarantees that the tyre changer functions at a high-performance level.

Das Spannutter verfügt über eine Sicherheitsvorrichtung, die ein versehentliches Schließen verhindert. Der Zylinder, der das Spannutter anhebt, verfügt über ein Sicherheitsventil, das ein versehentliches Hinunterfallen von Wagen und Rad verhindert. Ein hochpräzises Ventil garantiert, dass die Reifenmontiermaschine mit maximaler Leistung arbeitet.

INGOMBRI - OVERALL DIMENSIONS - PLATZBEDARF



Smontagomme appositamente studiato per avere il minimo degli ingombri e poter essere posizionato in qualsiasi luogo dell'officina. Le sue dimensioni contenute permettono pure l'installazione su camion per un servizio mobile

The tyre changer was expressly studied to take up the least amount of space and to be able to be positioned anywhere inside the garage. Its reduced dimensions even allow it to be installed on a truck for mobile service.

Eigens entwickelte Reifenmontiermaschine für minimalen Platzbedarf, die überall in der Werkstatt aufgestellt werden kann. Dank der geringen Abmessungen kann sie für einen mobilen Service auch auf dem LKW aufgestellt werden

DATI TECNICI - TECHNICAL DATA - TECHNISCHE DATEN

Larghezza max. ruota	Maximum wheel width	Max. Radbreite	695 mm (30")
Diametro max. ruota	Maximum wheel diameter	Max. Raddurchmesser	1400 mm
Motore centralina idraulica	Hydraulic control unit motor	Motor Hydraulikaggregat	0.75 Kw (3ph) 1.3 Kw (1ph)
Motore autocentrante	Turntable motor	Motor Spannutter	0.75 Kw (3ph) 1.1 Kw (1ph)
Peso massimo ruota	Maximum wheel weight	Maximales Radgewicht	700 kg
Forza stallonatura	Bead Breaking force	Abdrückkraft	14000 N
Voltaggio	Voltage	Spannung	400/230 V-3 ph-50/60 Hz 230 V-1 ph-50/60 Hz

DOTAZIONE

STANDARD EQUIPMENT
AUSSTATTUNG



ACCESSORI CONSIGLIATI

RECOMMENDED ACCESSORIES
EMPFOHLENES ZUBEHÖR

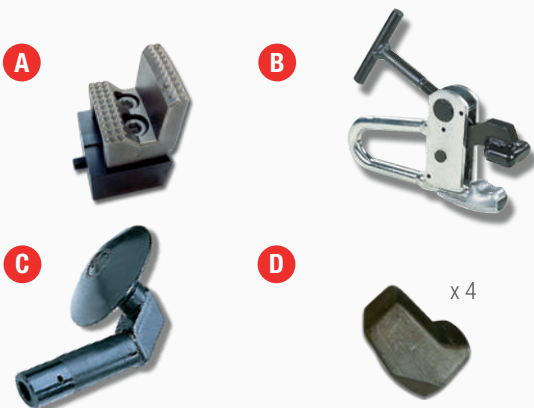

- A** 8-12100176
Prolunghe per autocentrante per cerchi senza flangia
Turntable extensions for flangeless rims
Verlängerungen für Spannutter für Felgen ohne Flansch
- B** 801227195
Pinza per cerchi in lega
Alloy rim clamp
Felgenzange für Leichtmetallfelgen
- C** 2016908
Disco stallonatore
Bead breaker disc
Abdrückscheibe
- D** 801254494
Set di 4 protezioni griffa per cerchi in lega
Set of 4 scratch protectors for alloy rims
Spannklauschutzkit (4 Stk.) für Leichtmetallfelgen

- Per maggiori informazioni consultare il catalogo accessori completo. - For further information, consult the complete accessories catalogue. - Für weitere Informationen schlagen Sie bitte im Gesamtkatalog des Zubehörs nach

INGOMBRI

OVERALL DIMENSIONS
PLATZBEDARF

Peso macchina
Machine Weight
Maschinenge-
wicht

500 kg

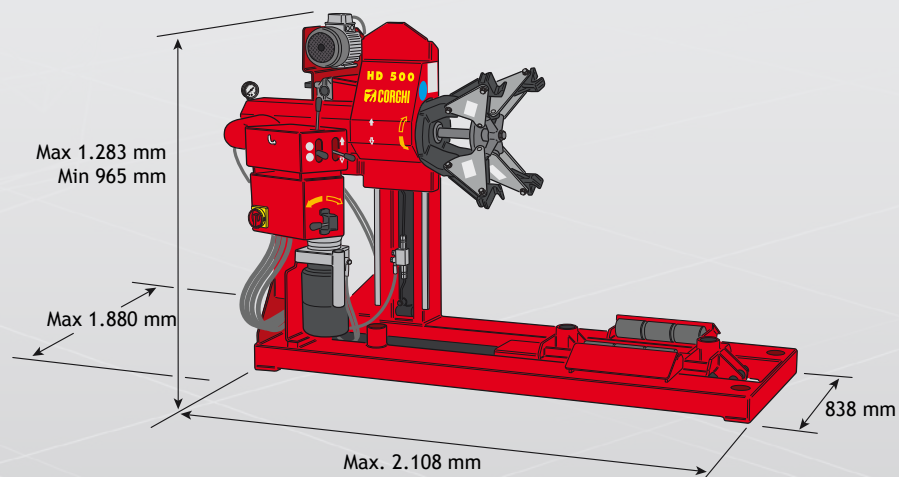

CORGHI S.p.A. a NEXION GROUP COMPANY
Strada Statale 468 n° 9 - 42015 CORREGGIO - R.E. - ITALY
Tel. ++39 0522 639.111 - Fax ++39 0522 639.150 - www.corgchi.com - info@corgchi.com



Fotografie, caratteristiche ed i dati tecnici non sono vincolanti, possono subire modifiche senza preavviso. The manufacturer reserves the right to modify the features of its products at any time. Les photographes, les descriptions et les données techniques ne sont pas contraignantes. Le fabricant se réserve le droit d'apporter des modifications sans préavis. Die Fotografien, die angegebenen Eigenschaften und die technischen Daten sind nicht verbindlich und können ohne Vorankündigung geändert werden. Fotos, charakteristische y datos técnicos no son vinculantes, pueden estar sujetos a modificaciones sin previo aviso. As fotografias, as características e os dados técnicos não são vinculantes, podem ser modificados sem prévio aviso. Code: DPCC000647A 07/2015

Per aiutare il pianeta ottimizzando il consumo di carta, i nostri cataloghi sono consultabili sul sito www.corgchi.com. Una stampa responsabile aiuta a preservare l'ambiente. To protect the planet and reduce paper usage, our catalogues are viewable online at the website www.corgchi.com. Printing responsibly contributes to saving the environment.

